

Quick Start Guide

Wireless IP Camera

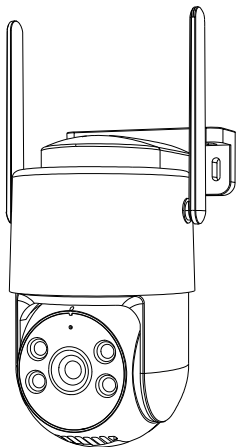

What's in the Box

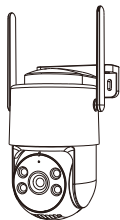

Camera

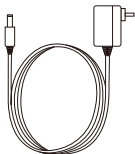

Power Adapter

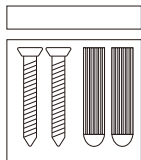

Mounting Screws



Mounting Templates



Quick Start Guide

NOTE: The number of accessories may vary by model.

Camera Introduction

Indicator Light/Luz indicadora

Infrared Lights/White Lights
Luz infrarroja/Luz blanca

Lens/ Lente

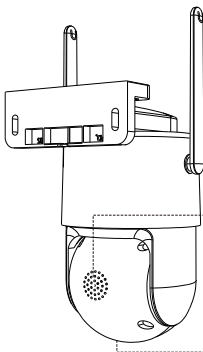
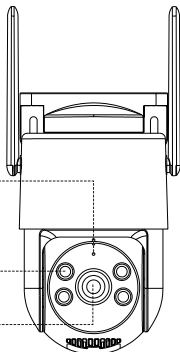

Speaker/Altavoz

TF Card Slot/ Reset Button

Ranura para tarjeta TF/
Botón de restablecimiento

Preparation Before Use

1. Install the TF Card

EN: Ensure the camera is powered off. The TF card slot is located underneath the camera sphere. Open the TF card rubber plug and insert the TF card into the slot.

NOTE: Insert or remove the card only when the camera is off. Use a FAT32-formatted TF card from a reputable brand. A read/write speed of at least U1/Class10 is recommended.

ES: Asegúrese de que la cámara esté apagada. La ranura para la tarjeta TF se encuentra en la parte inferior de la esfera. Abra el tapón de goma de la tarjeta TF e inserte la tarjeta TF en la ranura.

NOTA: Al instalar o retirar la tarjeta TF, la cámara debe estar apagada y desconectada de la alimentación para evitar dañar la tarjeta TF. Utilice una tarjeta TF de un fabricante reconocido. El dispositivo solo admite el formato Fat32. Asegúrese de que la tarjeta TF esté formateada en Fat32 antes de la instalación. Se recomienda que la velocidad de lectura y escritura de la tarjeta TF no sea inferior al nivel U1/Class10.

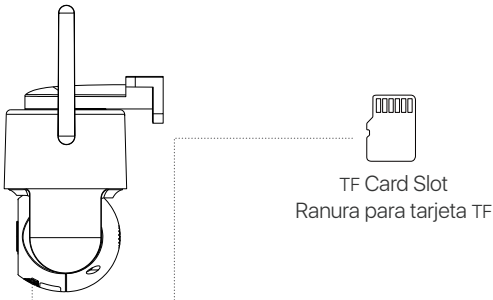

2. Power On the Device

EN: Connect the power cable to the camera's power port. The camera will power on automatically.

NOTE: During startup, the camera will emit a voice prompt. The indicator light will flash blue to signal network setup mode. Once connected, the indicator will stay solid blue.

ES: Conecte el cable de alimentación al puerto de alimentación de la cámara. La cámara se encenderá automáticamente.

NOTA: Durante el proceso de encendido, la cámara emitirá un tono de aviso y la luz indicadora parpadeará en azul para indicar que está esperando la configuración de la red. Una vez que la red esté conectada, la luz indicadora se mantendrá encendida.

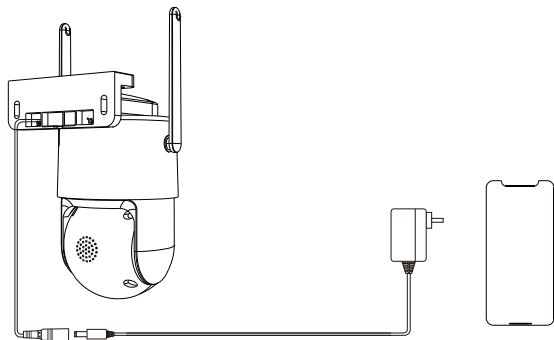

Connecting to the InstaVision App

1. Download the App

EN: Search for "InstaVision" in your mobile app store, or scan the QR code using your phone's browser or camera to download the app.

ES: Puede descargarlo buscando "InstaVision" en la tienda de aplicaciones móviles, o escaneando el código QR con el navegador o la cámara de su teléfono.



Apps and the App Store are trademarks of Apple Inc.



Google Play and the Google Play logo are trademarks of Google Inc.

2. Add Device

EN: A: Open the InstaVision app and follow the prompts to register and log in.

B: Tap "Add Camera" and follow the on-screen instructions to set up the network and complete device pairing.

NOTE: Follow the app instructions to complete installation, registration, and login. Please grant all required permissions to ensure full app functionality. Some features may not work properly if permissions are denied.

ES: A: Abra la aplicación InstaVision y siga las indicaciones para registrarse e iniciar sesión.

B: Haga clic en "Agregar cámara" y siga las instrucciones de la aplicación para configurar la configuración de red y completar la adición del dispositivo.

NOTA: Siga las indicaciones de la aplicación para completar la instalación, el registro e inicio de sesión del software. Durante la instalación y el uso de la aplicación, permita que la aplicación obtenga todos los permisos necesarios; de lo contrario, algunas funciones pueden no estar disponibles.

Mounting the Camera on the Wall

EN: Before installation, ensure the camera has been successfully added to the app.

ES: Antes de la instalación, asegúrese de que la cámara ya se haya agregado en la aplicación.

Installation Method: Wall Mount/Ceiling Mount

EN: ① Drill holes according to the mounting hole template. If needed, use the included wall anchors from the screw kit.

ES: ① Perfore agujeros según la plantilla de orificios. Si es necesario, use los tacos de expansión incluidos en el kit de tornillos.

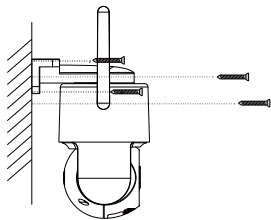
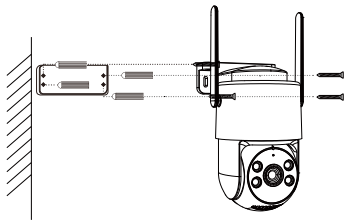

EN:

② Secure the camera base using the provided screws. Route the cable through the cable groove on the base.

ES:

② Fije la base de la cámara con los tornillos proporcionados. Pase el cable por la ranura de la base.

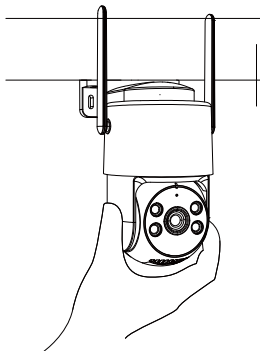
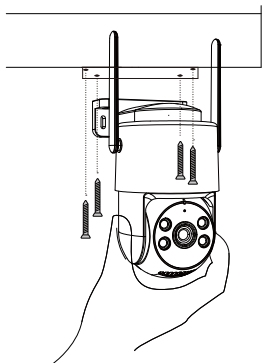
**Installation and Usage Guidelines****EN:**

- For better image quality, avoid pointing the camera directly at any light source.
- Regularly clean the lens with a soft cloth.
- Do not point the camera at glass windows or reflective surfaces, as infrared/ambient/status light reflections may affect image performance.
- Ensure the power port is not exposed to water, moisture, or blocked by dirt. Apply proper waterproofing measures.
- Avoid installing the camera where rain or snow may directly hit the lens.
- For optimal performance, keep the camera away from electronic devices (e.g., microwaves, TVs, cordless phones) to prevent signal interference.

ES:

- Para mejor calidad de imagen, evite apuntar la cámara hacia fuentes de luz.
- Limpie la lente regularmente con un paño suave.
- No apunte la cámara hacia ventanas de vidrio o superficies reflectantes, ya que los reflejos de luz infrarroja/ambiental/estado pueden afectar el rendimiento.
- Proteja el puerto de alimentación de agua, humedad o suciedad. Tome medidas impermeables.
- No instale la cámara donde la lluvia o nieve pueda golpear directamente la lente.
- Para óptimo rendimiento, manténgala alejada de dispositivos electrónicos (microondas, TV, teléfonos inalámbricos) para evitar interferencias.

FAQ

EN:

Q: Why is the device offline?

- Check if the device is connected to the network, if the router is working properly, and if the router has automatic IP address assignment enabled.

Q: Why can't I find the video recording files?

- Check if the TF card is damaged, if the search date is valid, and if the device's system time is set correctly.

Q: Why isn't the two-way talk feature working?

- Please check if all required app permissions were granted when installing the app on your phone.

Q: Why am I not receiving alarm notifications on the mobile app?

- Please check if push notifications are enabled in the app and if your phone allows the app to send notifications.

Q: Why can't I add the device in the app?

- Please check that the Wi-Fi name and password are entered correctly. If the problem persists, try resetting the device and adding it again.

ES:**P: ¿Por qué el dispositivo está fuera de línea?**

- Verifique si el dispositivo está conectado a la red, si el router funciona correctamente y si el router tiene asignación automática de dirección IP activada.

P: ¿Por qué no encuentro los archivos de grabación de video?

- Compruebe si la tarjeta TF está dañada, si la fecha de búsqueda es válida y si la hora del sistema del dispositivo está configurada correctamente.

P: ¿Por qué no funciona la función de intercomunicación?

- Verifique si se permitieron todos los permisos de la aplicación durante su instalación.

P: ¿Por qué la aplicación móvil no recibe notificaciones push de alarma?

- Compruebe si el interruptor de notificaciones push de la aplicación está activado y si el teléfono permite notificaciones push de esta aplicación.

P: ¿Por qué no se puede agregar el dispositivo a la aplicación?

- Verifique si el nombre de la WiFi y la contraseña ingresados al agregar el dispositivo son correctos. Puede restablecer el dispositivo e intentar agregarlo nuevamente.

Notification of Compliance

1. FCC Compliance Statement

This device complies with Part 15 of FCC Rules.

Operation is subject to the following two conditions:

- (1) This device may not cause harmful interference.
- (2) This device must accept any interference received, including interference that may cause undesired operation.

Simplified EU Declaration of Conformity

We declare that the device is in compliance with the essential requirements and other relevant provisions of Directive 2014/53/EU.



Correct Disposal of this Product

This marking indicates that this product cannot be disposed with other household wastes throughout the EU. To prevent possible harm to the environment or human health from uncontrolled waste disposal and promote the sustainable reuse of material resources, please recycle it responsibly. To return your used device, please visit the Return and Collection System or contact the retailer from whom the product was purchased. They can take this product away for environmentally safe recycling.

Notificación de Cumplimiento

1. Declaración de Cumplimiento de la FCC

Este dispositivo cumple con la Parte 15 de las Normas de la FCC.

La operación está sujeta a las siguientes dos condiciones:

- (1) Este dispositivo no puede causar interferencias perjudiciales,
- (2) Este dispositivo debe aceptar cualquier interferencia recibida, incluidas las inferencias que puedan provocar una operación no deseada.

Declaración de Conformidad de UE Simplificada

Declaramos que el dispositivo cumple con los requisitos esenciales y otras disposiciones relevantes de la Directiva 2014/53/UE.



Eliminación Correcta de este Producto

Esta marca indica que este producto no se puede desechar con otros residuos domésticos en toda la UE. Para evitar posibles daños al medio ambiente o la salud humana por la eliminación descontrolada de desechos y promover la reutilización sostenible de los recursos materiales, reciclelo de manera responsable. Para devolver su dispositivo usado, visite el Sistema de Devolución y Recolección o comuníquese con el minorista donde compró el producto. Pueden llevarse este producto para un reciclaje seguro para el medio ambiente.

NOTE: This equipment has been tested and found to comply with the limits for a Class B digital device, pursuant to part 15 of the FCC Rules. These limits are designed to provide reasonable protection against harmful interference in a residential installation. This equipment generates, uses and can radiate radio frequency energy and, if not installed and used in accordance with the instructions, may cause harmful interference to radio communications. However, there is no guarantee that interference will not occur in a particular installation. If this equipment does cause harmful interference to radio or television reception, which can be determined by turning the equipment off and on, the user is encouraged to try to correct the interference by one or more of the following measures:

- Reorient or relocate the receiving antenna.
- Increase the separation between the equipment and receiver.
- Connect the equipment into an outlet on a circuit different from that to which the receiver is connected.
- Consult the dealer or an experienced radio/TV technician for help.

Changes or modifications not expressly approved by the party responsible for compliance could void the user's authority to operate the equipment.

This device complies with Part 15 of the FCC Rules. Operation is subject to the following two conditions:

(1) this device may not cause harmful interference, and (2) this device must accept any interference received, including interference that may cause undesired operation.

RF Exposure Warning Statements:

This equipment complies with FCC radiation exposure limits set forth for an uncontrolled environment. This equipment shall be installed and operated with minimum distance 20cm between the radiator & body.

For USA: The frequency stability of all transmission frequencies of U-NII-1, U-NII 2A, U-NII 2C and U-NII-3 meets the requirements of 47 CFR FCC Part15.407(g), and the manufacturer declares that their transmission is maintained at Band U-NII-1, U-NII 2A, U-NII 2C and U-NII-3.

This device contains licence-exempt transmitter(s)/receiver(s) that comply with Innovation, Science and Economic Development Canada's licence-exempt RSS(s). Operation is subject to the following two conditions:

(1) This device may not cause interference.

(2) This device must accept any interference, including interference that may cause undesired operation of the device.

L'émetteur/récepteur exempt de licence contenu dans le présent appareil est conforme aux CNR d'Innovation, Sciences et Développement économique Canada applicables aux appareils radio exempts de licence. L'exploitation est autorisée aux deux conditions suivantes:

(1) L'appareil ne doit pas produire de brouillage;

(2) L'appareil doit accepter tout brouillage radioélectrique subi, même si le brouillage est susceptible d'en compromettre le fonctionnement.

ISED Radio Frequency Exposure Statement:

The device has been evaluated to meet general RF exposure requirements. The device can be used in mobile exposure conditions. The min separation distance is 20 cm.

ISED Déclaration d'exposition aux radiofréquences:

L'appareil a été évalué pour répondre aux exigences générales en matière d'exposition aux RF. L'appareil peut être utilisé dans des conditions d'exposition mobiles. La distance de séparation minimale est de 20 cm.

Operation of this device is restricted to indoor use only. (5150-5350MHz)

Le fonctionnement de cet appareil est limité à une utilisation en intérieur uniquement. (5150-5350MHz)

For Canada: The frequency stability of all transmission frequencies of U-NII-1, U-NII 2A, U-NII 2C and U-NII-3 meets the 47 CFR FCC Part15.407(g) requirements, and the manufacturer states that their transmissions remain within the U-NII-1, U-NII 2A, U-NII 2C and U-NII-3 bands.

Pour le Canada : La stabilité de fréquence de toutes les fréquences de transmission de U-NII-1, U-NII 2A, U-NII 2C et U-NII-3 est conforme aux exigences 47 CFR FCC Part15.407(g), et le fabricant déclare que leurs transmissions restent dans les bandes U-NII-1, U-NII 2A, U-NII 2C et U-NII-3.



Website: www.anlapus.com

E-Mail: support@instavision.ai

Phone: +1(877)916-3025

All rights reserved. No part of this publication may be reproduced by any means without written permission from Anlapus. The information in this publication is believed to be accurate in all respects. Anlapus cannot assume responsibility for any consequences resulting from the use thereof. The information contained herein is subject to change without notice. Revisions or new editions to this publication may be issued to incorporate such changes.



RoHS

F92111100012220